

SKU NUMBER#: 662187525877

VIGOROUS LED SPORTS LIGHT

POWER: 500 W | CCT: 3000 K | COLOR: Black

Product Description:

Rlux Vigorous LED Sports Light is made of aluminum alloy composition and has a rugged die-cast design with integrated cooling fans, all of which ensure optimum heat dissipation. The product supports a multi-faceted optic design which not only helps distribute light evenly but also reduces glare. With seamless link of aerometal materials and numerous vents on the heat sink, Vigorous offers improved heat management and a stable light system, making it a perfect choice for all kinds of outdoor stadiums.

Features:

- Superior aesthetics with a modern look.
- Excellent heat management system courtesy of multiple vents.
- 240° adjustable angle.
- Multi-faceted optic design to distribute light evenly and reduce glare.
- Inputs voltage range: 100 - 277 / 277 - 480 V, 50 - 60 Hz.

Ordering Information

Part Number	Fixture Type	Dimming	Wattage	CCT	Voltage	CRI	Light Distribution	Internal
50	XX	D	YYYYW	C	V	R	X	Y

Series Code

Model Number	Wattage	CCT Optional	CRI	Efficacy	Lens Type
5001D0500WCVRXY	500 W	3000 K	80+	150.2 lm/W	PC Lens

Fixture Details

Electrical

Power	496.2 W
Voltage	100-277 V
Current	4.16 A
Power Factor	0.952
Total Harmonic Distortion (THD)	9.9%
Surge Protection	6 kV

Construction

Housing	Die-cast Aluminum
Cover Material / Lens	PC Lens
Base / Power Supply	Sosen
Finish	Black
Effective Projected Area (EPA)	1.59 ft ²
Number of LEDs	704
Wind Shear Rating	127.5 mph

LifeSpan

Average Life (Hours)	1,00,000
Warranty (Years)	5

Lighting Performance

Lumens	74529.24 lm
Efficacy	150.2 lm/W
Color Temperature (CCT)	3000 K
Color Rendering (CRI)	73.5
Beam Angle	30°
Light Distribution	Type I, Very Short
PCB Thickness	0.6 mm
Typical LED Lumen	140 lm
Dimmable Lighting Control	Continuous Dimming to 10% or Below

Components

LED Light Source	LUMILEDS
Driver	Sosen

Environment

Operating Temperature	-22 °F ~ +122 °F
Ingress Protection Rating (IP)	IP66
Impact Protection Rating	IK10

Fixture Dimension

Width (Inches)	16.33"
Height (Inches)	19.65"
Diameter (Inches)	15.94"
Net Weight (lbs)	27.55

Packaging Dimension

Box Dimensions (Inches)	17.71" x 17.71" x 13.97"
Box Weight (lbs)	31.96
Quantity Per Box	1

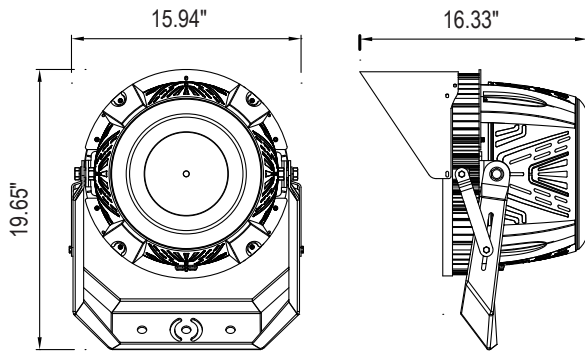
Qualifications

Model Number	5001D0500WCVRXY
SKU Number	662187525877

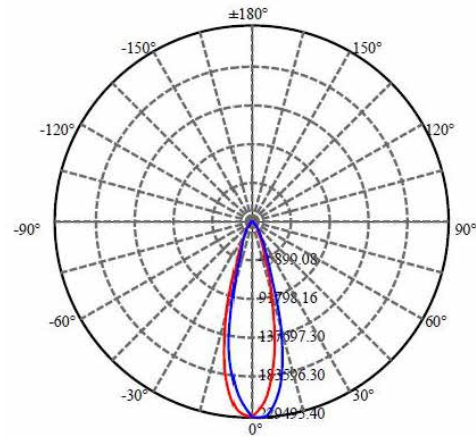
Optometric Data
500 W

Accessories

INCLUDE IN THE BOX

662187526065	Shield
662187526072	Yoke Mount Kit

SOLD SEPARATELY

662187526089	Slip Fitter Mounting Bracket
662187526096	Laser Aiming Device
662187526102	Synapse-Wireless Control System